





-  **OVAL Manwaydoor inwards opening**
-  **Porte OVALE avec ouverture à l'intérieur**
-  **Ovale Mannlochtür, schwenkbar nach innen (Innenöffnung)**
-  **Puerta OVAL de apertura interna**
-  **Portella Ovale apertura interna**



- ◆ 7027 555
- ◆ 7027 565
- ◆ 7027 580



STANDARD SIZE/* At temperature 50°C /122 °F

CODE	A	E×C	B	t	P.MAX
	mm	mm	mm	mm	bar
7027 555	440×340	555×455×5	75	4.0	3.0
7027 565	440×340	565×465×5	100	4.0	3.0
7027 580	440×340	580×480×5	133	4.0	3.0

IF YOU WANT TO CHECK FOR MORE DETAILS
PLEASE CHECK THE FOLLOWING DRAWING

*1BAR ≈14.5PSI=0.1MPA

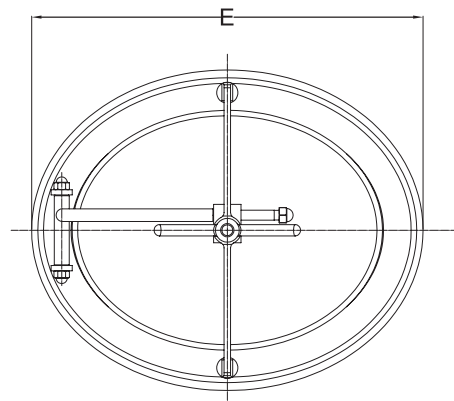
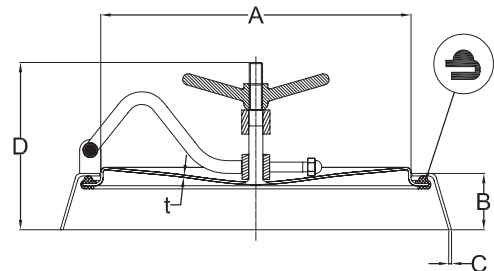

NKA Parts Drawing

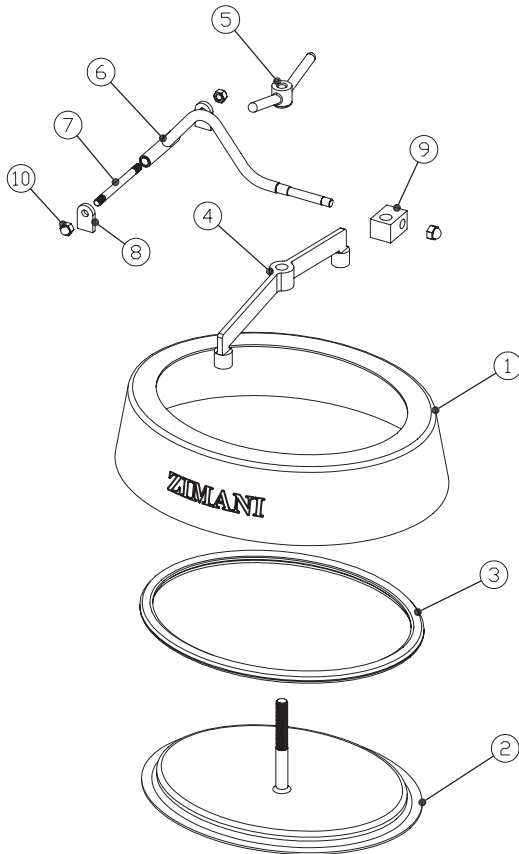

GASKET

Part No.	Material	Color
7010-07 1	Silicon	White
7010-07 2	EPDM	Black
7010-07 3	FPM	Black

Item	Description	Material	Qty
1	Frame	1.4301/1.4404	1
2	Cover	1.4301/1.4404	1
3	Gasket	EPDM	1
4	Bracket	T304	1
5	Top nut	T304	1
6	Suspension arm	T304	1
7	Screw	T304	1
8	Hinge ear	T304	2
9	Hub	T304	1
10	Nut	T304	3

NKA Technology

TECHNICAL DATA

Working pressure: Acc. to table standard size.

Certificates

EN10204. 3.1 certificate

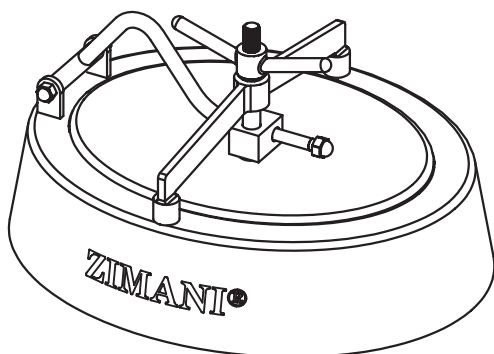

Options

Stainless Steel Finishes

POLISHED WITH RA (μ)

BEAD BLASTED

PICKLED : ON REQUEST

ELECTRO POLISHED

Cover & Frame Range

Cover Thickness	Frame/Neck Height
4.0mm	75mm(2.95")
	100mm (3.94")
	133mm(5.23")

Note: Longer heights are also available.